

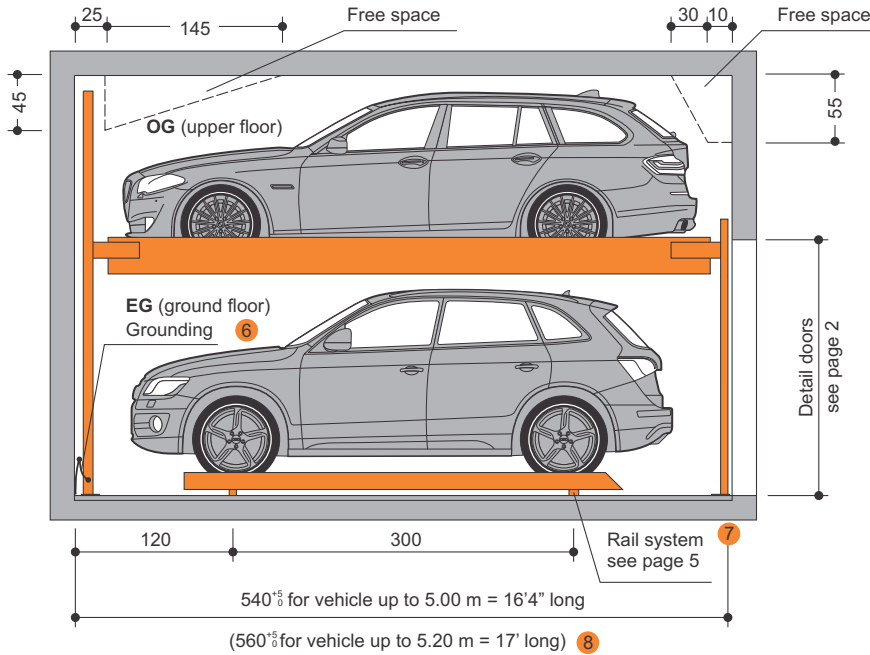

KLAUS Multiparking Systems Pvt. Ltd.
5/3, Prashant Apartments, Erandwane,
Pune 411 004 INDIA
Phone **+91-20-2545 0378 / 8662**
Fax **+91-20-2544 6360**
E-mail **info@klausmultiparking.in**
Website **www.klausindia.com**

PRODUCT DATA

**Parking Automat P210
2000 kg¹**



Dimensions

Tolerances for space requirements ⁺³%. 3
Dimensions in cm.

Suitable for

Standard passenger cars
According to clearance and maximal surface load.

	Standard
Width	190 cm 4
Weight	max. 2000 kg
Wheel load	max. 500 kg

Clearance profile

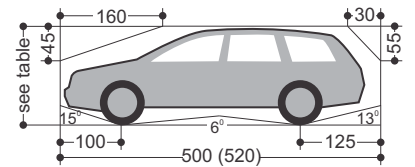

P210-345

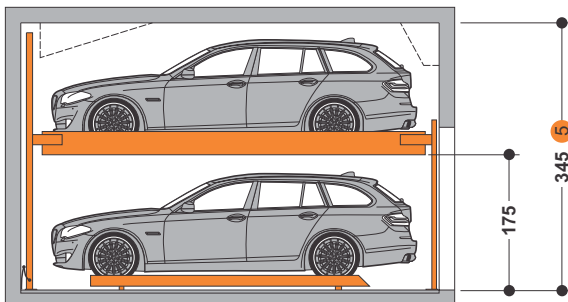

Height	Car height	
	OG	EG
345	150	165

P210-405

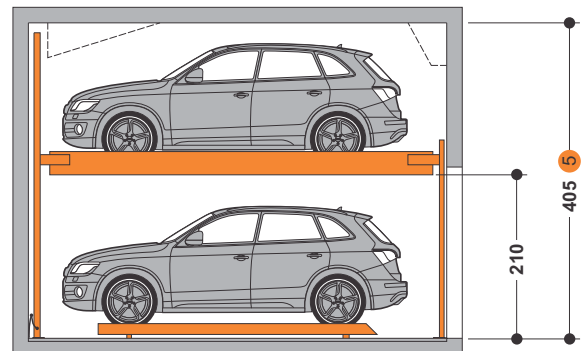

Height	Car height	
	OG	EG
405	175	200

- 1 Standard type
 - 2 Spare no.
 - 3 To follow the minimum finished dimensions, make sure to consider the tolerances during construction.
 - 4 Car width for platform width 230 cm. If wider platforms are used, it is also possible to park wider cars.
 - 5 If height H is larger, vehicles with the maximum height as applicable for the EG can be parked on the OG, provided there is free space available on the ceiling.
 - 6 Potential equalization from foundation grounding connection to system (provided by the customer).
 - 7 Tolerances for the evenness of the driveway (floor) must be strictly followed.
 - 8 For convenient use of your parking space and due to the fact that the cars keep becoming longer, we recommend a length of 560 cm.
- !** If sprinklers are required, make sure to provide the necessary free spaces during the planning stage.

Garages with sliding doors (standard) | Width dimensions

Sliding door behind columns

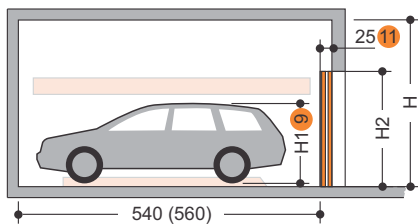

Type	H	H1	H2
P210-345	345	165	210
P210-405	405	200	220

Columns per each grid unit

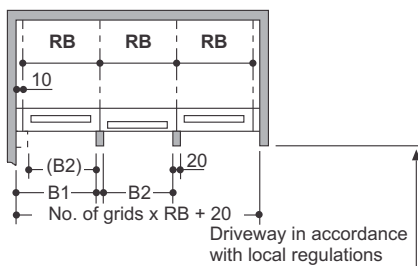

Usable platform width				
OG	EG	RB ¹⁰	B1	B2
220	200	240	240	220
230	200	250	250	230
240	210	260	260	240
250	220	270	270	250
260	230	280	280	260
270	240	290	290	270

Columns every second grid unit

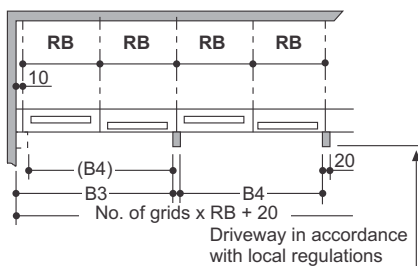

Usable platform width				
OG	EG	RB ¹⁰	B3	B4
220	200	240	480	460
230	200	250	500	480
240	210	260	520	500
250	220	270	540	520
260	230	280	560	540
270	240	290	580	560

Sliding door between columns

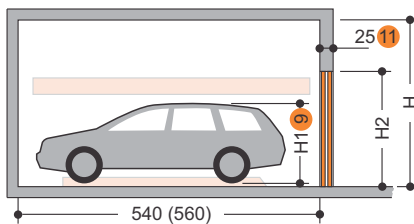

Type	H	H1	H2
P210-345	345	165	220
P210-405	405	200	230

Columns per each grid unit

Not available

Columns every second grid unit

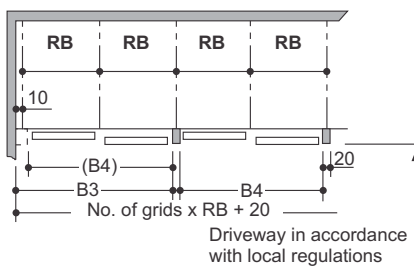

Usable platform width				
OG	EG	RB ¹⁰	B3	B4
220	200	240	480	460
230	200	250	500	480
240	210	260	520	500
250	220	270	540	520
260	230	280	560	540
270	240	290	580	560

Sliding door in front of columns

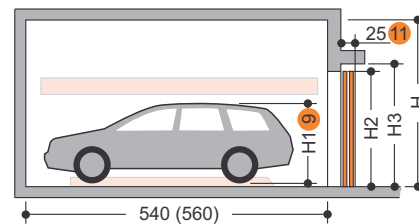

Type	H	H1	H2	H3
P210-345	345	165	210	220
P210-405	405	200	220	230

Columns per each grid unit

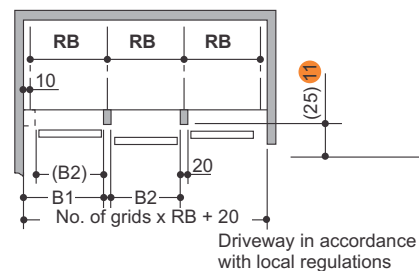

Usable platform width				
OG	EG	RB ¹⁰	B1	B2
220	200	240	240	220
230	200	250	250	230
240	210	260	260	240
250	220	270	270	250
260	230	280	280	260
270	240	290	290	270

Columns every second grid unit

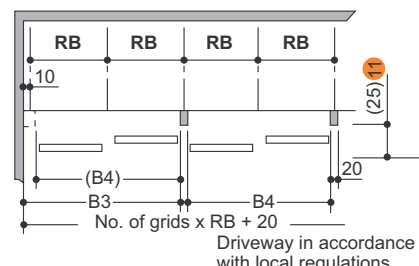

Usable platform width				
OG	EG	RB ¹⁰	B3	B5
220	200	240	480	460
230	200	250	500	480
240	210	260	520	500
250	220	270	540	520
260	230	280	560	540
270	240	290	580	560

! End parking spaces are generally more difficult to drive into. Therefore, we recommend our wider platforms for end parking spaces. Parking larger vehicles on standard width platforms may make getting into and out of the vehicle difficult. This depends on the type of the vehicle, approach and above all, on the driver's skill.

- 9** H1 = Height of the vehicle on ground floor platform.
- 10** RB = Grid unit width **must** strictly conform to dimensions quoted.
- 11** Applies to manually operated doors only.

Garages with roll doors | Width dimensions

Roll door behind columns

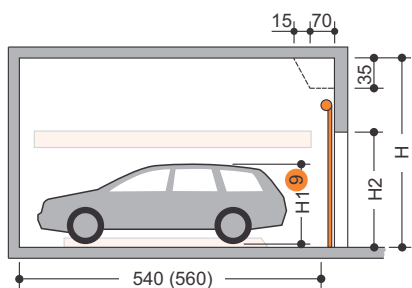

Type	H	H1	H2	height
P210-345	345	165	210	263
P210-405	405	200	220	300

Columns per each grid unit

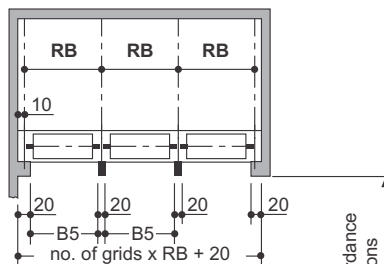

Usable platform width			
OG	EG	RB	B5
220	200	240	220
230	200	250	230
240	210	260	240
250	220	270	250
260	230	280	260
270	240	290	270

Driveway in accordance with local regulations

! End parking spaces are generally more difficult to drive into. Therefore, we recommend our wider platforms for end parking spaces. Parking larger vehicles on standard width platforms may make getting into and out of the vehicle difficult. This depends on the type of the vehicle, approach and above all, on the driver's skill.

- 9** H1 = Height of the vehicle on ground floor platform.
- 10** RB = Grid unit width **must** strictly conform to dimensions quoted.

Approach

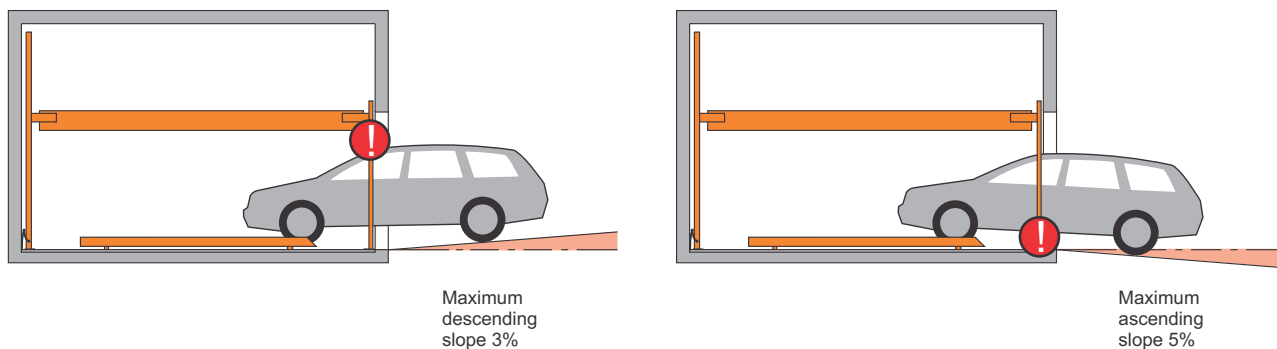

! The illustrated maximum approach angles must not be exceeded. Incorrect approach angles will cause serious maneuvering and positioning problems on the parking system for which the local agency of KLAUS Multiparking accepts no responsibility.

Longitudinal free space

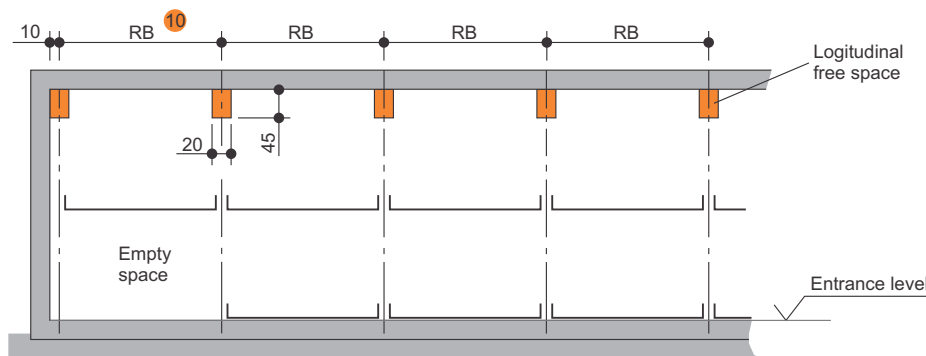

- 10** RB = Grid unit width **must** strictly conform to dimensions quoted

- Page 1
 - Section
 - Dimensions
 - Car data
- Page 2
 - Width dimensions
- Page 3
 - Width dimensions
 - Approach
 - Free spaces
- Page 4
 - Function
 - Load plan
- Page 5
 - Rails
- Page 6
 - Electrical data
 - Technical data
 - To be performed by the customer
- Page 7
 - Description

Function with standard numbering and identification of parking levels

e.g. for parking space No. 4: Check first that all doors are closed, then select No. 4 on operating panel.

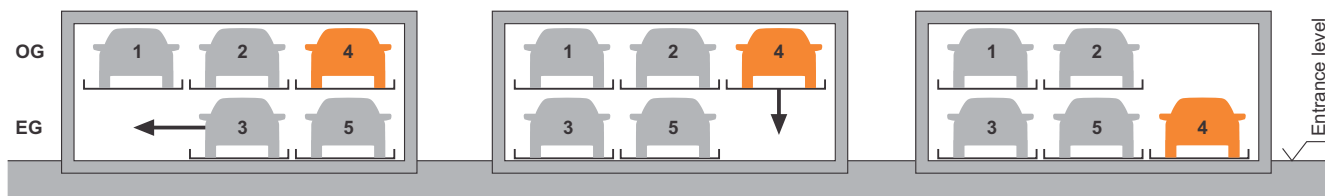

For driving the vehicle off platform no. 4, the ground floor parking platforms are shifted to the left.

The empty space is now below the vehicle which shall be driven off the platform. Platform no. 4 will be lowered.

The vehicle on platform no. 4 can now be driven off the platform.

Load plan

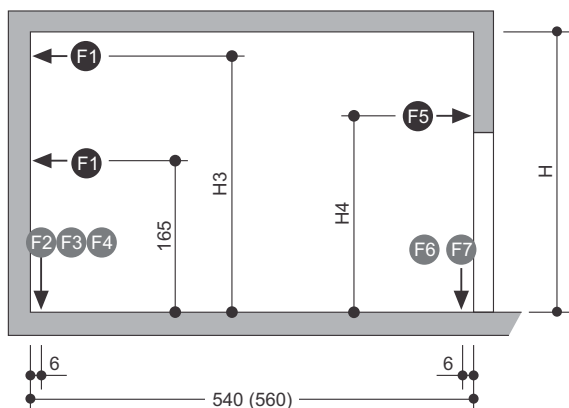

Type	H	H3	H4
P210-345	345	310	225
P210-405	405	345	260

Load plan-top view

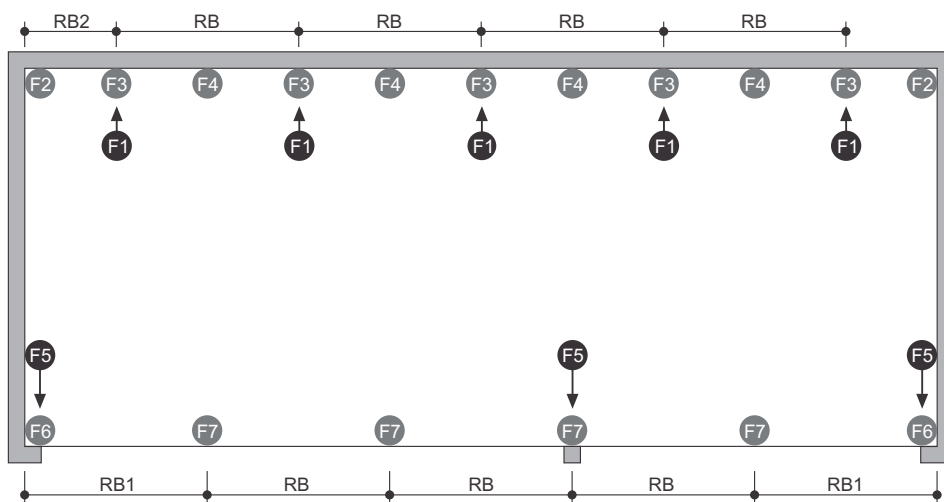

Usable platform width	RB ¹⁰	RB1	RB2
220	240	250	125
230	250	260	135
240	260	270	140
250	270	280	145
260	280	290	150
270	290	300	155

Platform load	F1	F2	F3	F4	F5	F6	F7	¹²
2000 kg	±2	-9	+38	-18	ca.+0,5	+9	+18	-14

! The system is doweled to floor and walls. The drilling depth in the floor is approx. 15 cm. The drilling depth in the walls is approx. 12 cm. Floor and walls are to be made of concrete (grade of concrete min. C20/25). The dimensions for the points of support are rounded values. If the exact position is required, please contact KLAUS Multiparking.

¹⁰ RB = Grid unit width **must** strictly conform to dimensions quoted.

¹² All forces in kN (static loads)

Recess / Rail system

Dependent upon the structural conditions of the garage, several different options are available for installation of the rails.

Rail load by moving EG platform
 For surface load 2000 kg: 6,5 kN per wheel

Laying on strip foundation 13

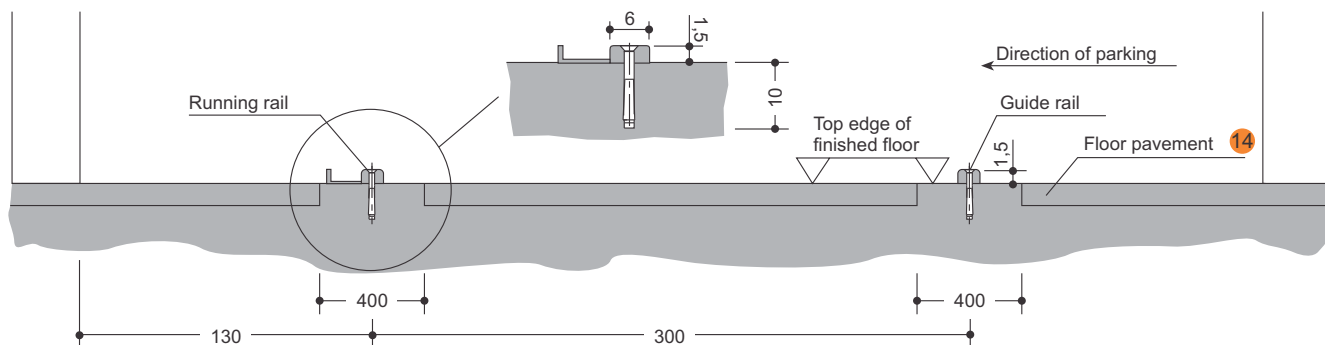

Laying on finished floor 13

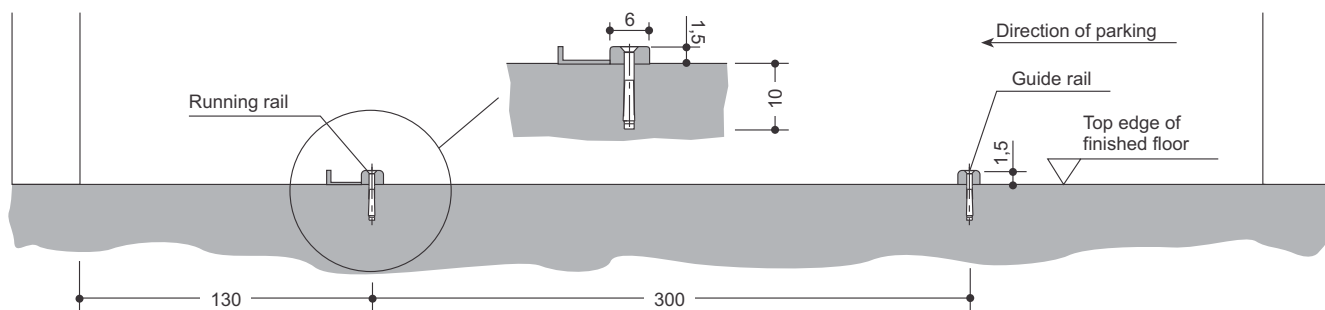

- 13 Tolerances for the evenness of the driveway must be strictly followed as mentioned in the table of evenness and tolerances below. No expansion joints are permitted within the area of the rail system.
- 14 We do not recommend tar flooring.

Evenness and Tolerances (abstract from DIN 18 202, table 3)

The distance between the lower flange of the park boards and the garage ground must therefore not exceed 2 cm. To adhere to the safety regulations and recommendations and to get necessary even ground, the tolerance of evenness must not be exceeded. Therefore, exact leveling of the ground by the client is essential.

Column	1	2	3	4	5	6
Line	Reference	Vertical measurement as limits in mm with measuring points distances in m to 15				
2	Unfinished to surface of covers, subconcrete and subsoils for higher demands, e.g. as foundation for cast plaster floor, industrial soils, paving tiles and slabstone paving, compound floor paving. Finished surfaces for minor purposes, e.g. warehouses, cellar.	0,1	1	4	10	15
3	Finished grounds, e.g. floor pavement serving as foundation for coverings. Covering, tile coverings, PVC flooring and glued coverings.	5	8	12	15	20
		2	4	10	12	15

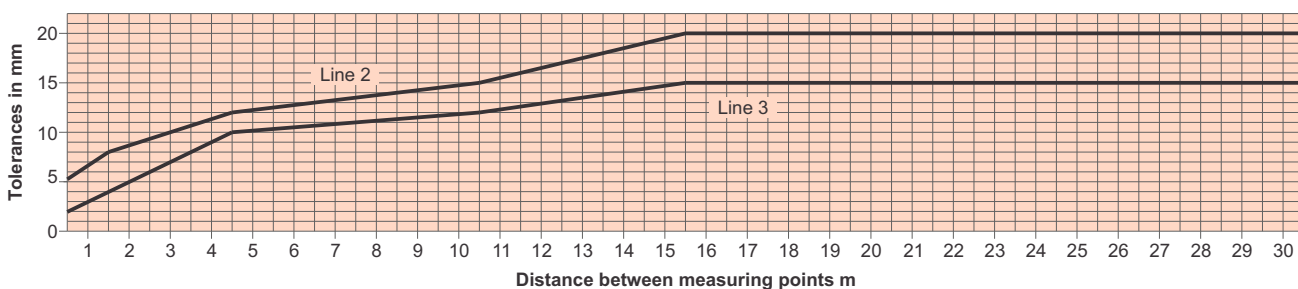

- 15 Intermediate values are to be taken out of the diagram and must be rounded-off to mm.

- Page 1
-Section
-Dimensions
-Car data
- Page 2
-Width
-dimensions
- Page 3
-Width
-dimensions
-Approach
-Free
-spaces
- Page 4
-Function
-Load plan
- Page 5
-Rails
- Page 6
-Electrical
-data
-Technical
-data
-To be
-performed
-by the
-customer
- Page 7
-Description

Electrical data

Control box

The control box must be accessible at all times from outside.
 Dimensions approx.
 Cutting through of wall from control box to parking system (contact the local agency of KLAUS Multiparking for clarification).

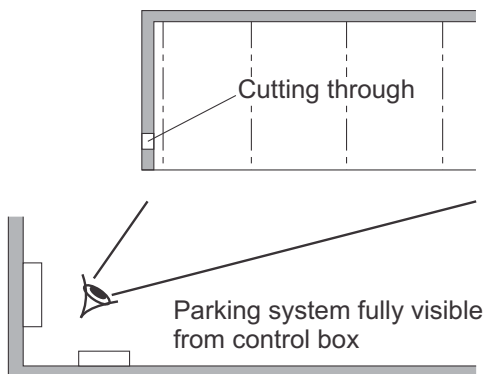

Electrical supply to the control box/Foundation earth connector

3 phase, 415 VAC ($\pm 10\%$), 50 Hz ($\pm 2\%$), 4 wire (3 PH + N + PE) electrical supply to the control box through a 4 pole RCBO (or MCB + ELCB), 25 Amp. IDN (sensitivity/leakage current) 100 mA.

Supply line cable 5 x 4.0 mm², copper (3 PH + N + PE) with marked wire and protective conductor. Local regulations must be taken into consideration.

Electrical supply to the control box must be provided by the customer during installation. The functionality can be monitored on site by our fitters together with the electrician. If this cannot be done during installation for some reason for which the customer is responsible, the customer must commission an electrician at his own expense and risk.

Safety of machinery, electrical equipment, grounding of the steel structure is necessary, provided by the customer (distance between grounding max. 10 m).

Operating device

Easy-to-survey positioning (e.g. on column).
 Protection against unauthorized use.
 May also be recessed in wall if required.

Technical data

Field of application

Generally parking system is suitable for the same car length for which the wheel-stop is adjusted at the time of installation. In case different car is to be parked, wheel-stop adjustment confirmation from KLAUS Multiparking shall be required.

Care

To avoid damages resulting from corrosion, make sure to follow our cleaning and care instructions and to provide good ventilation of your garage.

Environmental conditons

Environmental conditions for the area of multiparking systems: Temperature range 5°C to +40°C. Relative humidity 50% at a maximum outside temperature of +40°C.

If lifting or lowering times are specified, they refer to an environmental temperature of +10° C and with the system set up directly next to the hydraulic unit. At lower temperatures or with longer hydraulic lines, these times increase.

Numbering

Standard numbering of the parking spaces



Different numbering is only possible at extra cost.
 Please take note of the following specifications.
 In general, the empty space must be arranged to the left.
 The numbers must be provided 8-10 weeks before the delivery date.

To be performed by the customer

Safety fences

Any constraints that may be necessary in order to provide protection, for pathways directly in front, next to or behind the unit. This is also valid during construction.

Numbering of parking spaces

Consecutive numbering of parking spaces.

Building services

Any required lighting, ventilation, fire extinguishing and fire alarm systems as well as clarification and compliance with the relevant regulatory requirements.

Wall cuttings

Any necessary wall cuttings.

Door suspension

The lintel height H2 (see page 2) is absolutely necessary. With differing heights, additional fixings are required at extra charge.

Door shields

The lintel height H2 (see page 2) is absolutely necessary. With differing heights, additional fixings are required at extra charge.

Floor/Rails

Flooring structure in accordance with our instructions, please see page 5 (recesses, rail systems.)

Recesses, tolerances for the evenness of the driving lane must adhere to table mentioned on page no 5.

Stuffing of rail system with cement floor for the whole length.
 Bringing in of floor pavement.

Electrical supply to the control box / Foundation earth connector

Suitable electrical supply to the control box must be provided by the customer during installation. The functionality can be monitored on site by our fitters together with the electrician. If this cannot be done during installation for some reason for which the customer is responsible, the customer must commission an electrician at his own expense and risk.

Safety of machinery, electrical equipments, grounding of the steel structure is necessary, provided by the customer (distance between grounding max. 10 m).

Page 1
-Section
-Dimensions
-Car data

Page 2
-Width dimensions

Page 3
-Width dimensions
-Approach
-Free spaces

Page 4
-Function
-Load plan

Page 5
-Rails

Page 6
-Electrical data
-Technical data
-To be performed by the customer

Page 7
-Description

Description

General description

KLAUS Multiparking System provides independent parking spaces for cars, one on top of the other and side by side.

Dimensions are in accordance with the underlying dimensions of height and width.

The parking bays are accessed horizontally (installation deviation $\pm 1\%$).

Along the complete width of the Parking Automat, an approach lane (driving lane in accordance with local regulations) must be available. Parking spaces are arranged on two different levels, one level on top of the other.

The platforms of the upper floor (OG) are moved vertically, the platform on the ground floor (EG) horizontally. At approach level (EG) there is always one parking space less available. This vacant space is used for shifting the ground floor (EG) parking spaces sideways, thus enabling the upper platform (OG) parking space located above to be lowered to approach/ground level. Consequently, a unit of three parking spaces (1 on the ground floor, 2 on the upper floor) is the smallest unit available for this parking system.

For safety reasons, it is recommended to install safety doors at the entrance.

A steel framework mounted on to the floor consists of

- Supports
- Steel pillars with sliding platform supports
- Cross and longitudinal members
- Running rails for transversely movable ground floor (EG) platforms

Platforms consist of

- Side members
- Cross members
- Platform base sections
- 1 wheel-stop (on the right per parking space)
- Screws, small parts, etc.

Lifting device for upper floor (OG) platforms

- Hydraulic cylinder with solenoid valves
- Chain wheels
- Chains
- Limit switches
- The platforms are suspended on four points and guided along the supports using plastic sliding bearings

Drive unit of transversely movable platforms on the ground floor (EG)

- Gear motor with chain wheel
- Chains
- Running and guide rollers (low-noise)
- Power supply via cable

Hydraulic unit consists of

- Hydraulic power unit (low-noise, installed onto a console with a metal mounting)
- Hydraulic oil reservoir
- Oil filling
- Internal geared wheel pump
- 3-phase-AC-motor (3.0 kW, 415 VAC, 50 Hz)
- Pressure gauge
- Pressure relief valve
- Hydraulic hoses

Control system

- Central operator panel (operating device) used to select the desired parking space.
- With series installation, the doors are opened manually.
- Electric wiring is made from the electric cabinet by the manufacturer.

Description

Laterally movable doors

Size

Sliding door, dimensions: approx. 2500 mm x 2000 mm (width x height).

Frame

Frame construction with vertical centre stay made from extruded aluminium sections.

Safety doors

Door suspensions are not included in the standard version, but can be delivered at additional cost as special equipment.

Door actuation

Standard

- Manually, i.e. the door is opened and closed by hand

Running rails

- The running gear of each door consists of 2 twin-pair rolling gadgets, adjustable in height.
- The running rails of the doors are fixed to brackets or the concrete lintel, or on a building-specific door suspension using ceiling fittings.
- The guide consists of 2 plastic rollers mounted on to a base plate, which is doweled to the floor.

We reserve the right to change these specifications without prior notice.

KLAUS Multiparking reserves the right in the course of the technical progress to use newer or other technologies, system, processes, procedures or standards in the fulfillment of their obligations other than those originally offered.