



**KLAUS Multiparking Systems Pvt. Ltd.**  
5/3, Prashant Apartments, Erandwane,  
Pune 411 004 INDIA  
Phone **+91-20-2545 0378 / 8662**  
Fax **+91-20-2544 6360**  
E-mail **info@klausmultiparking.in**  
Website **www.klausindia.com**

## PRODUCT DATA

### Parking Automat P310 2000 kg <sup>1</sup>

#### Dimensions

Tolerances for space requirements <sup>+3</sup> <sup>3</sup>  
Dimensions in cm.

#### Suitable for

Standard passenger cars  
According to clearance and maximal  
surface load

	Standard
Width	190 cm <sup>4</sup>
Weight	max. 2000 kg
Wheel load	max. 500 kg

#### Clearance profile

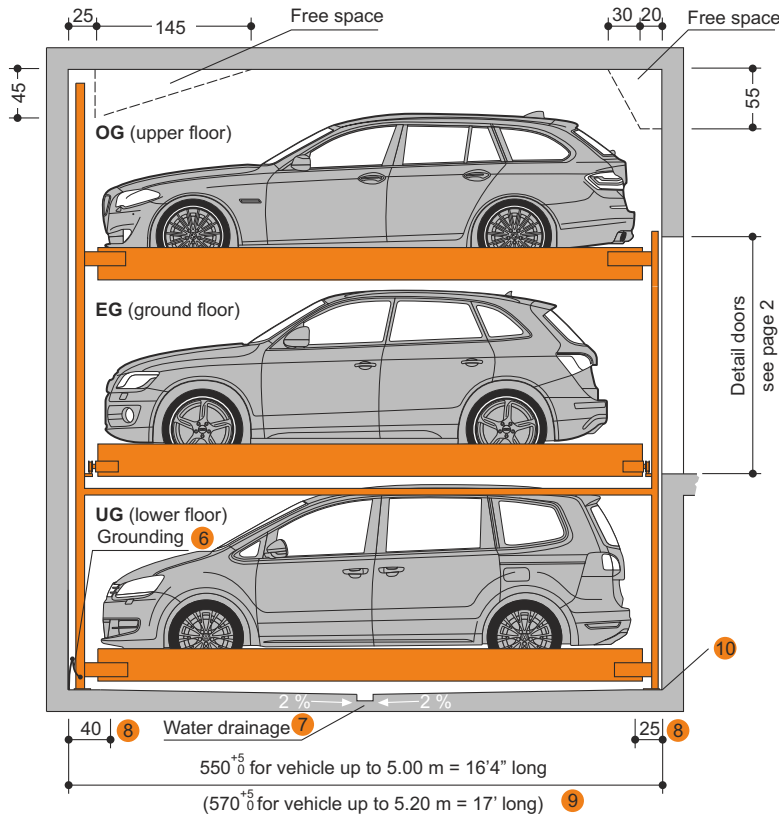
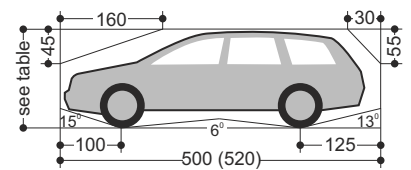

**P310-175**

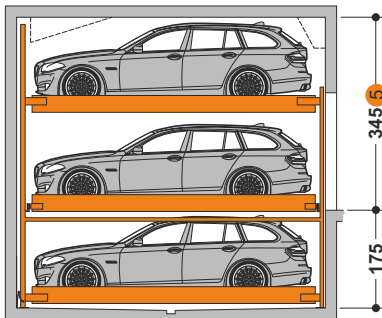

Height	Car height		
	OG	EG	UG
345	150	170	150

**P310-200**

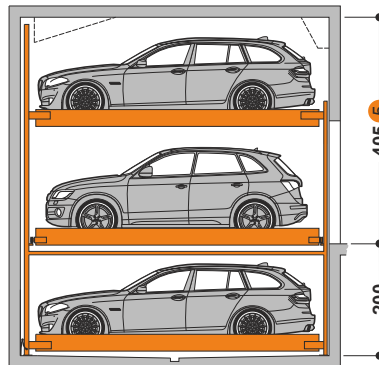

Height	Car height		
	OG	EG	UG
405	175	200	175

**P310-225**

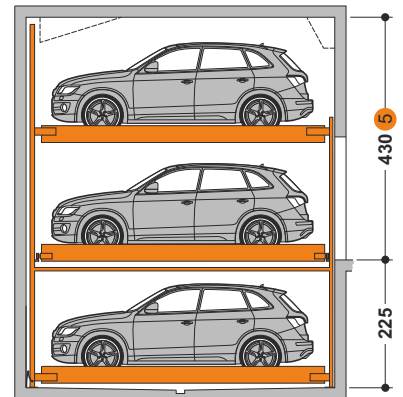

Height	Car height		
	OG	EG	UG
430	200	200	200

- <sup>1</sup> Standard type
- <sup>2</sup> Spare no.
- <sup>3</sup> To follow the minimum finished dimensions, make sure to consider the tolerances, during construction.
- <sup>4</sup> Car width for platform width 230 cm. If wider platforms are used, it is also possible to park wider cars.
- <sup>5</sup> If height H is larger, vehicles with the maximum height as applicable for the EG can be parked on the OG, provided there is free space available on the ceiling.
- <sup>6</sup> Potential equalization from foundation grounding connection to system (provided by the customer).
- <sup>7</sup> Slope with drainage channel and sump.
- <sup>8</sup> These floor areas need to be horizontal and equal level across the full width of the pit.
- <sup>9</sup> For convenient use of your parking space and due to the fact that the cars keep becoming longer we recommend a pit length of 570 cm.
- <sup>10</sup> At the transition section between pit floor and walls no hollow moldings/ coves are possible. If hollow moldings/ coves are required, the systems must be designed smaller or the pits accordingly wider.

**!** If sprinklers are required, make sure to provide the necessary free spaces during the planning stage.

## Garages with sliding doors (standard) | Width dimensions

Page 1  
-Section  
-Dimensions  
-Car data

Page 2  
-Door  
-Width dimensions

Page 3  
-Width dimensions  
-Approach  
-Free spaces

Page 4  
-Function  
-Load plan

Page 5  
-Electrical data  
-Technical data  
-To be performed by the customer

Page 6  
-Description

### Sliding door behind columns

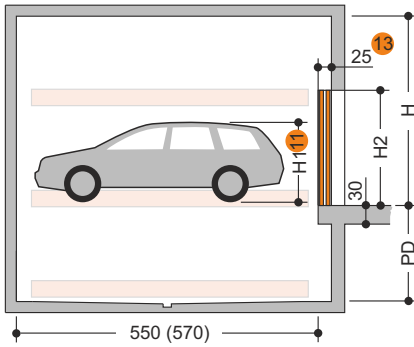

Type	PD	H	H1	H2
P310-175	175	345	170	210
P310-200	200	405	205	220
P310-225	225	430	200	220

### Columns per each grid unit

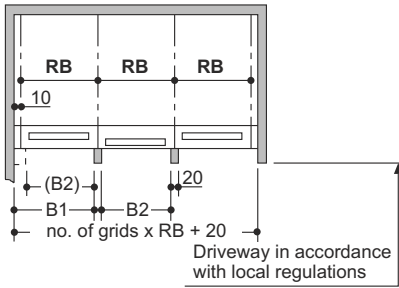

Usable platform width	RB <sup>12</sup>	B1	B2
220	240	240	220
230	250	250	230
240	260	260	240
250	270	270	250
260	280	280	260
270	290	290	270

### Columns every second grid unit

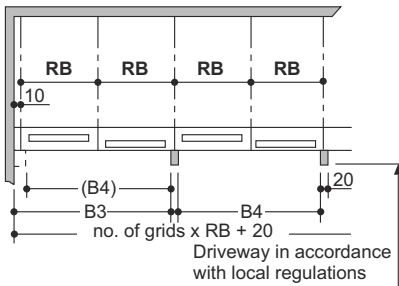

Usable platform width	RB <sup>12</sup>	B3	B4
220	240	480	460
230	250	500	480
240	260	520	500
250	270	540	520
260	280	560	540
270	290	580	560

### Sliding door between columns

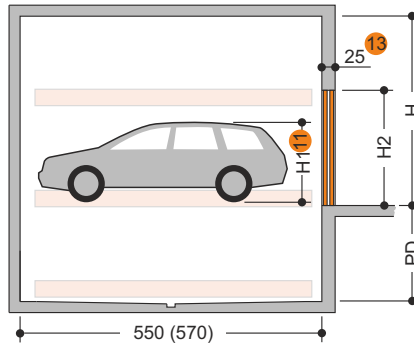

Type	PD	H	H1	H2
P310-175	175	345	170	220
P310-200	200	405	205	230
P310-225	225	430	200	230

### Columns per each grid unit

Not available

### Columns every second grid unit

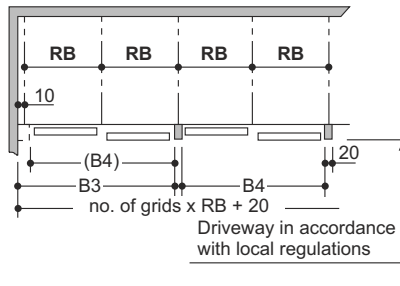

Usable platform width	RB <sup>12</sup>	B3	B4
220	240	480	460
230	250	500	480
240	260	520	500
250	270	540	520
260	280	560	540
270	290	580	560

### Sliding door in front of columns

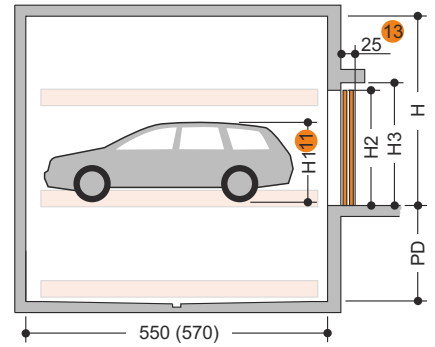

Type	PD	H	H1	H2	H3
P310-175	175	345	170	210	220
P310-200	200	405	205	220	230
P310-225	225	430	200	220	230

### Columns per each grid unit

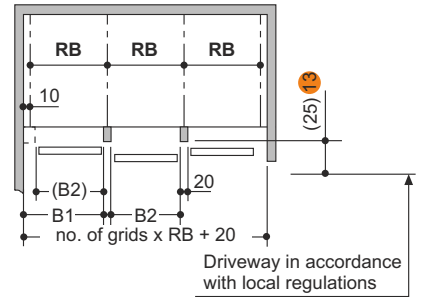

Usable platform width	RB <sup>12</sup>	B1	B2
220	240	240	220
230	250	250	230
240	260	260	240
250	270	270	250
260	280	280	260
270	290	290	270

### Columns every second grid unit

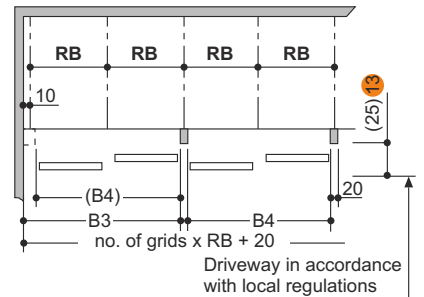

Usable platform width	RB <sup>12</sup>	B1	B5
220	240	480	460
230	250	500	480
240	260	520	500
250	270	540	520
260	280	560	540
270	290	580	560

**!** End parking spaces are generally more difficult to drive into. Therefore, we recommend our wider platforms for end parking spaces. Parking larger vehicles on standard width platforms may make getting into and out of the vehicle difficult. This depends on the type of the vehicle, approach and above all, on the driver's skill.

**11** H1 = Height of the vehicle on ground floor (EG) platform.

**12** RB = Grid unit width **must** strictly conform to dimensions quoted.

**13** Applies to manually operated doors only. The electricity driven doors must have 35 cm.

## Garages with roll doors | Width dimensions

### Roll door behind columns

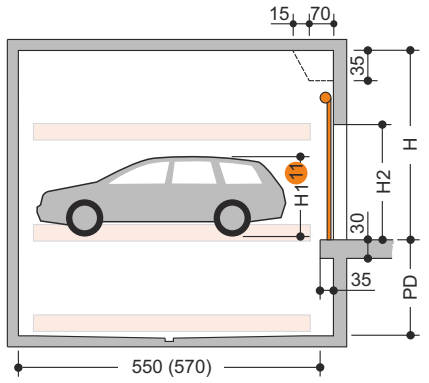

Type	PD	H	H1	H2	Roll door height
P310-175	175	345	170	210	263
P310-200	200	405	205	220	300
P310-225	225	430	200	220	300

### Columns per each grid unit

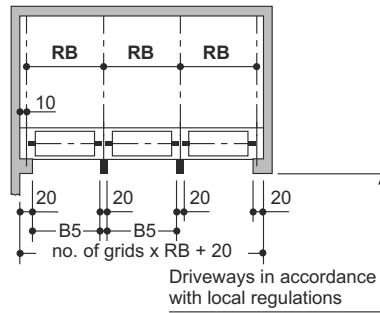

Usable platform width	RB <sup>12</sup>	B5
220	240	220
230	250	230
240	260	240
250	270	250
260	280	260
270	290	270

**!** End parking spaces are generally more difficult to drive into. Therefore, we recommend our wider platforms for end parking spaces. Parking larger vehicles on standard width platforms may make getting into and out of the vehicle difficult. This depends on the type of the vehicle, approach and above all, on the driver's skill.

<sup>11</sup> H1 = Height of the vehicle on ground floor platform.

<sup>12</sup> RB = Grid unit width **must** strictly conform to dimensions quoted.

## Approach

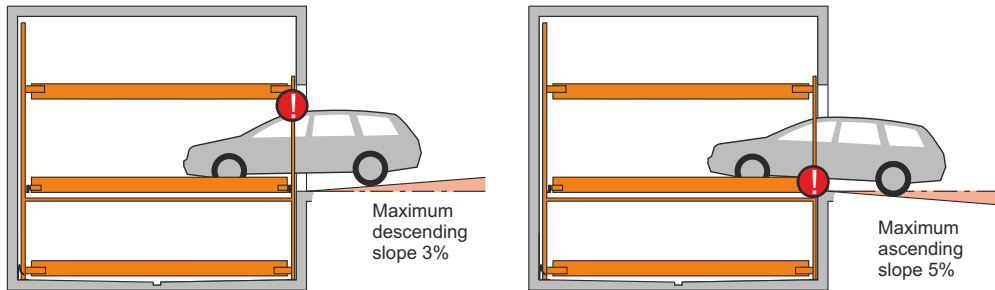

**!** The illustrated maximum approach angles must not be exceeded. Incorrect approach angles will cause serious maneuvering and positioning problems on the parking system for which the local agency of KLAUS Multiparking accepts no responsibility.

## Longitudinal free space

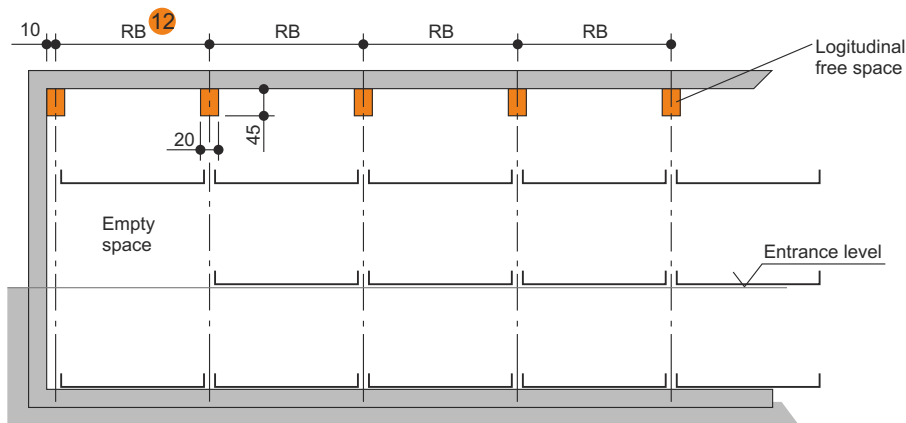

<sup>12</sup> RB = Grid unit width **must** strictly conform to dimensions quoted.

Page 1  
-Section  
-Dimensions  
-Car data

Page 2  
-Door  
-Width dimensions

Page 3  
-Width dimensions  
-Approach  
-Free spaces

Page 4  
-Function  
-Load plan

Page 5  
-Electrical data  
-Technical data  
-To be performed by the customer

Page 6  
-Description

## Function with standard numbering and identification of parking levels

e.g. for parking space No. 8:  
Check first that all doors are closed, then select No. 8 on operating panel.

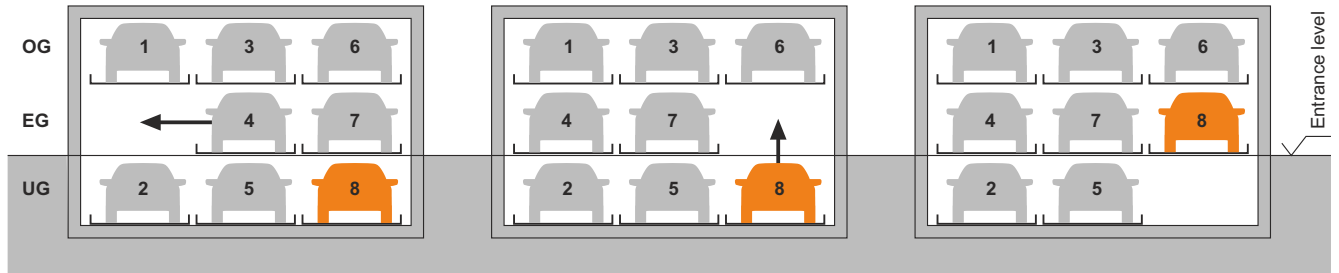

For driving the vehicle off platform No. 8 the ground floor parking platforms are shifted to the left.

The empty space is now above the vehicle which shall be driven off platform. Platform no. 8 will be lifted.

The vehicle on platform no. 8 can now be driven off the platform.

## Load plan

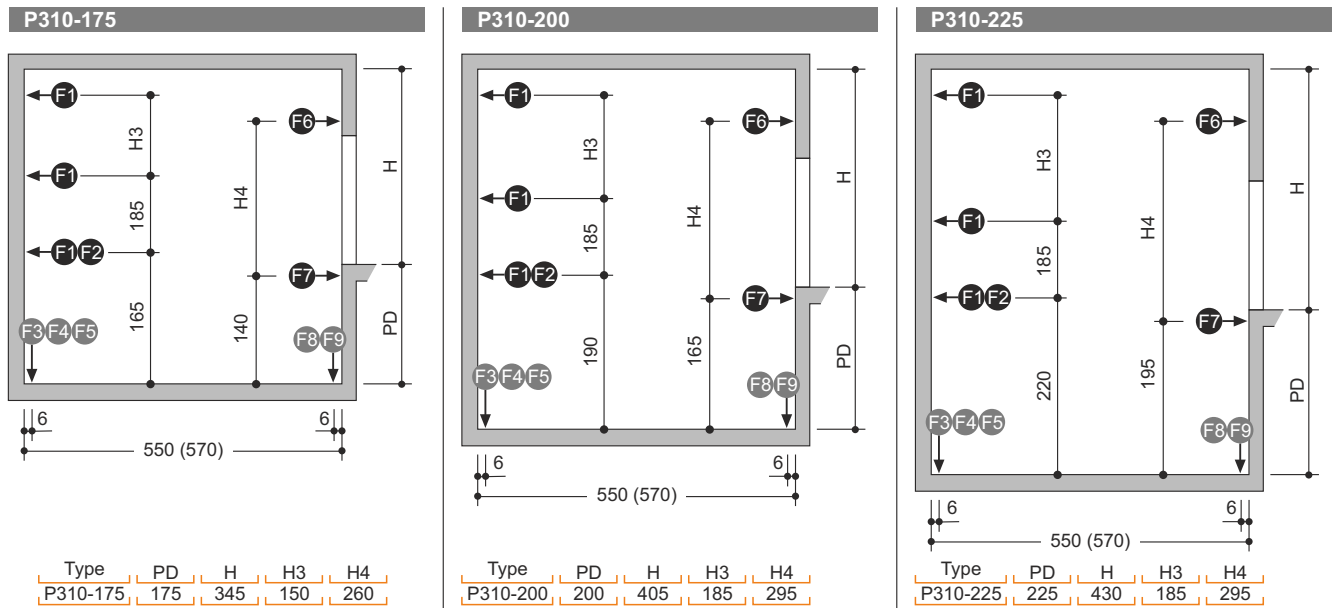

## Load plan-top view

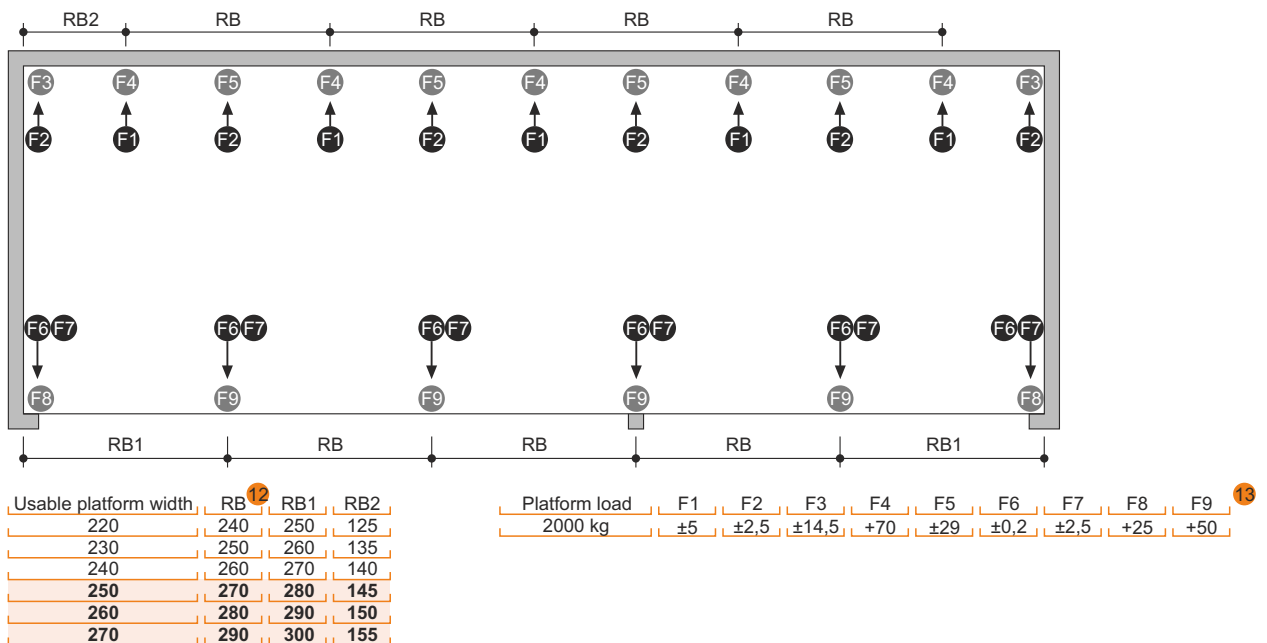

**!** The system is doweled to floor and walls. The drilling depth in the floor is approx. 15 cm. The drilling depth in the walls is approx. 12 cm. Floor and walls are to be made of concrete (grade of concrete min. C20/25)  
The dimensions for the points of support are rounded values. If the exact position is required, please contact KLAUS Multiparking.

<sup>12</sup> RB = Grid unit width **must** strictly conform to dimensions quoted

<sup>13</sup> All forces in kN (static loads)

- Page 1  
-Section  
-Dimensions  
-Car data
- Page 2  
-Door  
-Width  
-Width dimensions
- Page 3  
-Width dimensions  
-Approach  
-Free spaces
- Page 4  
-Function  
-Load plan
- Page 5  
-Electrical data  
-Technical data  
-To be performed by the customer
- Page 6  
-Description

## Electrical data

### Control box

The control box must be accessible at all times from outside.

Dimensions approx. 100 x 100 x 30 cm.

Cutting through of wall from control box to parking system (contact the local agency of KLAUS Multiparking for clarification).

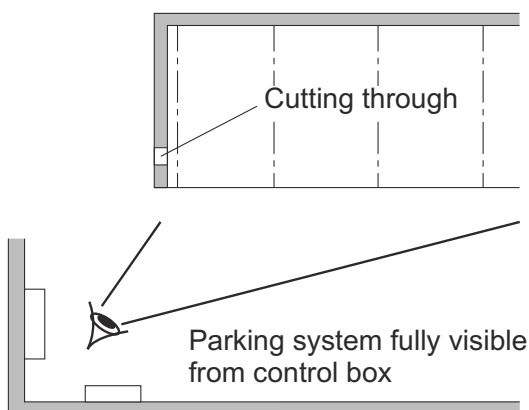

### Electrical supply to the control box/Foundation earth connector

3 phase, 415 VAC (±10%), 50 Hz (±2%), 4 wire (3 PH + N + PE) electrical supply to the control box through a 4 pole RCBO (or MCB + ELCB), 25Amp. IDN (sensitivity/leakage current)100 mA.

Supply line cable 5 x 4.0 mm<sup>2</sup>, copper (3 PH + N + PE) with marked wire and protective conductor. Local regulations must be taken into consideration.

Electrical supply to the control box must be provided by the customer during installation. The functionality can be monitored on site by our fitters together with the electrician. If this cannot be done during installation for some reason for which the customer is responsible, the customer must commission an electrician at his own expense and risk.

Safety of machinery, electrical equipment, grounding of the steel structure is necessary, provided by the customer (distance between grounding max. 10 m).

### Operating device

Easy-to-survey positioning (e.g. on column).

Protection against unauthorized use.

May also be recessed in wall if required.

## Technical data

### Field of application

Generally parking system is suitable for the same car length for which the wheel-stop is adjusted at the time of installation. In case different car is to be parked, wheel-stop adjustment confirmation from KLAUS Multiparking shall be required.

### Care

To avoid damages resulting from corrosion, make sure to follow our cleaning and care instructions and to provide good ventilation of your garage.

### Environmental conditons

Environmental conditions for the area of Multiparking systems. Temperature range +5°C to +40° C. Relative humidity 50% at a maximum outside temperature of +40° C.

If lifting or lowering times are specified, they refer to an environmental temperature of +10° C and with the system set up directly next to the hydraulic unit. At lower temperatures or with longer hydraulic lines, these times increase.

### Numbering

Standard numbering of the parking spaces:

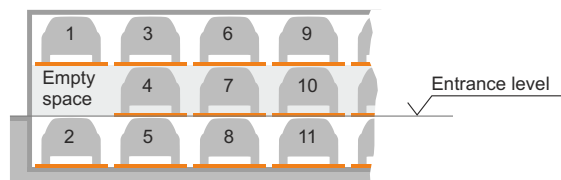

Initial position: lower floor platform No. 2 at entrance level (covering of pit, safety regulation).

Different numbering is only possible at extra cost.

Please take note of the following specifications.

In general, the empty space must be arranged to the left.

The numbers must be provided 8-10 weeks before the delivery date.

## To be performed by the customer

### Safety fences

Any constraints that may be necessary in order to provide protection for the park pits for pathways directly in front, next to or behind the unit. This is also valid during construction.

### Numbering of parking spaces

Consecutive numbering of parking spaces.

### Building services

Any required lighting, ventilation, fire extinguishing and fire alarm systems as well as clarification and compliance with the relevant regulatory requirements.

### Drainage

For the middle area of the pit, we recommend a drainage channel, which is connected to a floor drain system or sump (50 x 50 x 20 cm). The drainage channel may be inclined to the side, however not the pit floor itself (longitudinal incline is available). In the interest of environmental protection we recommend painting the pit floor. Oil and petrol separators must be provided according to the statutory provisions when connecting to the public sewage system.

### Wall cuttings

Any necessary wall cuttings.

### Strip footings

If due to structural conditions strip footings must be effected, the customer shall provide an accessible platform reaching the top of the said strip footings to enable and facilities the mounting work.

### Electrical supply to the control box/Foundation earth connector

Suitable electrical supply to the control box must be provided by the customer during installation. The functionality can be monitored on site by our fitters together with the electrician. If this cannot be done during installation for some reason for which the customer is responsible, the customer must commission an electrician at his own expense and risk.

Safety of machinery, electrical equipments, grounding of the steel structure is necessary, provided by the customer (distance between grounding max. 10 m).

### Door suspension

The lintel height H2 (see page 2) is absolutely necessary. With differing heights, additional fixings are required at extra cost.

### Door shields

Door shields may be necessary. If desired, they can be ordered from KLAUS Multiparking for an additional cost.

Page 1  
-Section  
-Dimensions  
-Car data

Page 2  
-Door  
-Width  
-Width  
-dimensions

Page 3  
-Width  
-dimensions  
-Approach  
-Free  
-spaces

Page 4  
-Function  
-Load plan

Page 5  
-Electrical  
-data  
-Technical  
-data  
-To be  
-performed  
-by the  
-customer

Page 6  
-Description

## Description

### General description

KLAUS Multiparking System provides independent parking spaces for cars, one on top of the other and side by side.

Dimensions are in accordance with the underlying dimensions of parking pit, height and width.

The parking bays are accessed horizontally.

Along the complete width of the Parking Automat, an approach lane (during lane in accordance with local regulations) must be available. This vacant space is used for shifting the ground floor (EG) parking spaces sideways, thus enabling an upper floor (OG) parking space or lower floor (UG) parking space to be lowered or lifted to approach level. Consequently, a unit of five parking spaces (2 on the upper floor, 1 on the ground floor, 2 on the lower floor) is the smallest unit available for this parking system.

The platforms of both the lower floor (UG) and upper floor (OG) are moved vertically, the platforms of the ground floor (EG) horizontally. At approach level (EG) there is always one parking space less available. This vacant space is used for shifting the ground floor (EG) parking spaces sideways, thus enabling an upper floor (OG) parking space or lower floor (UG) parking space to be lowered or lifted to approach level. Consequently, a unit of five parking spaces (2 on the upper floor, 1 on the ground floor, 2 on the lower floor) is the smallest unit available for this parking system.

The Parking Automat P310 allows parking of passenger cars and station wagons.

For safety reasons, it is recommended to install safety doors at the entrance.

### A steel framework mounted inside the pit consists of

- Supports
- Steel pillars with sliding platform supports
- Cross and longitudinal members
- Running rails for the transversely movable ground floor (EG) platform

### Platforms consist of

- Side members
- Cross members
- Platform base sections
- 1 wheel-stop (on the left per parking space)
- Screws, small parts, etc.

### Lifting device for upper floor (OG) and lower floor (UG) platforms

- Hydraulic cylinder with solenoid valve
- Chain wheel
- Chains
- Limit switches
- The platforms are suspended on four points and guided along the supports using plastic sliding bearings.

### Drive unit of transversely movable platforms on the ground floor (EG)

- Gear motor with chain wheel
- Chains
- Running and guide rollers (low-noise)
- Power supply via cable

### Hydraulic unit consists of

- Hydraulic power unit (low-noise, installed onto a console with a metal mounting)
- Hydraulic oil reservoir
- Oil filling
- Internal geared wheel pump
- 3-phase-AC-motor (3.0 kW, 415 VAC, 50 Hz)
- Pressure gauge
- Pressure relief valve
- Hydraulic hoses

### Control system

- Central operator panel (operating device ) used to select the desired parking space.
- With series installation, the doors are opened manually.
- Electric wiring is made from the electric cabinet by the manufacturer.

### Laterally movable doors

#### Size

Sliding door, dimensions: approx. 2500 mm x 2000 mm (width x height).

#### Frame

- Frame construction with vertical centre stay made from extruded aluminium sections.

#### Safety doors

Doors and door suspensions are not included in the standard version but can be delivered at additional cost as special equipment.

#### Door actuation

- Manually, i.e. the door is opened and closed by hand

For safety reasons the movement of the platforms as always mode behind locked doors.

#### Door rails

- The running gear of each door consists of 2 twin-pair rolling gadgets, adjustable in height
- The running rails of the doors are fixed to brackets or the concrete lintel, or on a building-specific door suspension using ceiling fittings
- The guide consists of 2 plastic rollers mounted to a base late, which is doweled to the floor

**We reserve the right to change these specifications without prior notice.**

KLAUS Multiparking reserves the right in the course of the technical progress to use newer or other technologies, system, processes, procedures or standards in the fulfillment of their obligations other than those originally offered.